

Fig.3

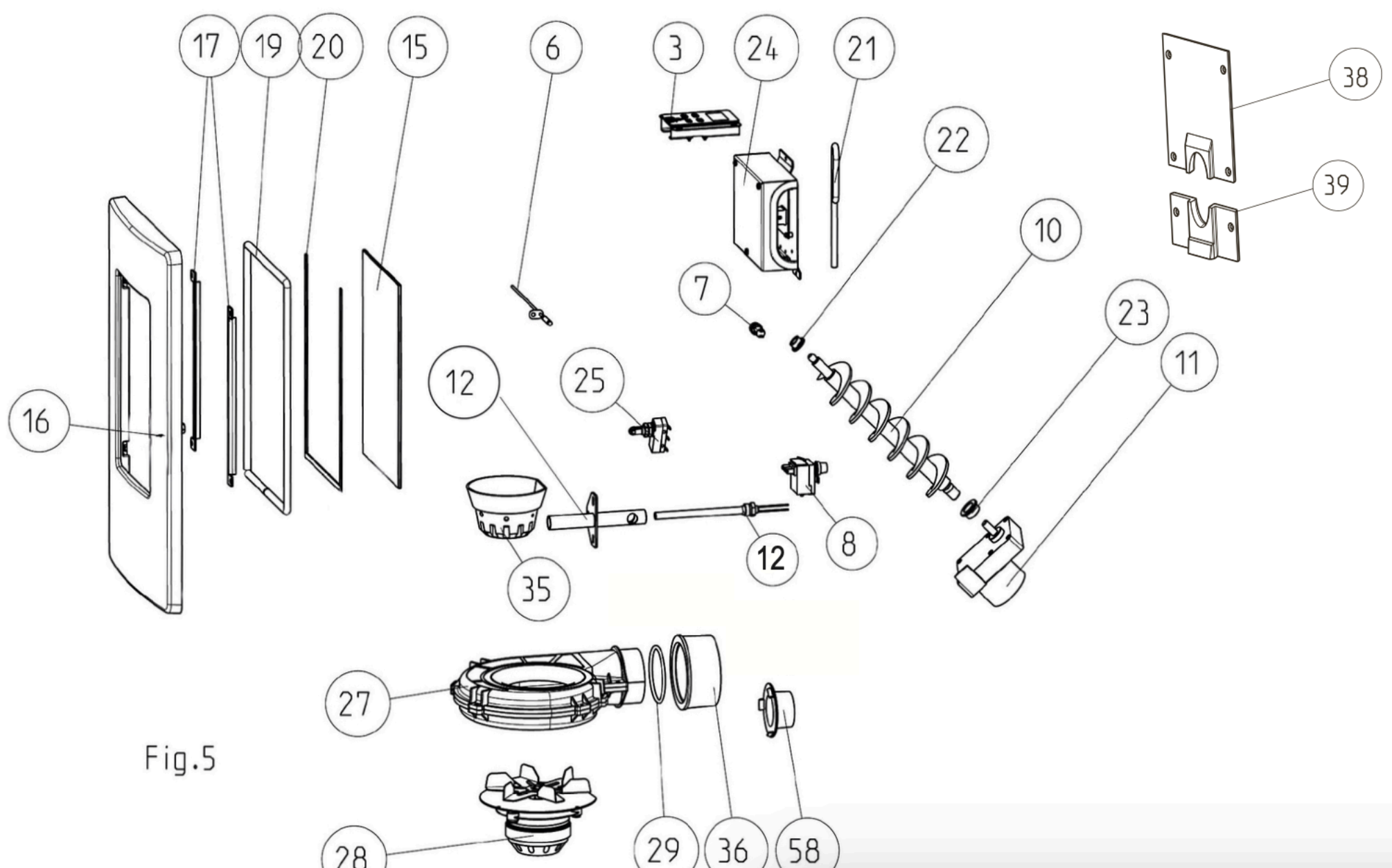

Fig.5